



# Aeroex Technologies Inc.

## Oil Mist Collector

Model ARO-400/600

Multi-Stage



## Installation & Service Manual

[www.aeroex.com](http://www.aeroex.com)

705-734-0199

[sales@aeroex.com](mailto:sales@aeroex.com)

[orderdesk@aeroex.com](mailto:orderdesk@aeroex.com)



## Table of Contents

Specifications.....	3
Installation instructions.....	4
Installation Kit.....	5
Oil drain hose Kit.....	5
Electrical Connection.....	6
Direction of rotation.....	6
Wiring Connection.....	7
Maintenance.....	8
Filter options Coolant.....	9
Filter options Oil.....	10
Dimensions.....	11
Warranty.....	12



## Model ARO-400/600 Specifications

### **AEROEX – Oil Mist Collector**

For highly effective separation of coolant and oil mists including smoke from metalworking machinery and oil reservoirs.

#### **Consisting of:**

Powdered coated mild steel housing.

Motor and fan impeller.

-For Coolant, the primary separation pack consists of a 1st stage ME and 2<sup>nd</sup> stage AG agglo, 3<sup>rd</sup> stage fiber bed filter. Final filtration, 4<sup>th</sup> stage HEPA filter.

-For Oil, the primary separation pack consists of a 1st stage ME and 2<sup>nd</sup> and 3<sup>rd</sup> stage multi-layer fiber bed filter. Final filtration, 4<sup>th</sup> stage HEPA filter.

#### **Specifications:**

Model	CFM	Sound dB(A)	Machine Tool Enclosure Volume ft <sup>3</sup>	Motor hp	Voltage RPM	Amps	RPM
ARO-400 6" inlet	350-500	68	125	1.0 External Motor	230/3/60 460/3/60 575/3/60	3.2 1.3 1.2	3450
ARO-600 6" inlet	600-700	70	200	1.0 External Motor	230/3/60 460/3/60 575/3/60	3.2 1.3 1.2	3450
ARO-600 8" inlet	700-800	70	250	1.0 External Motor	230/3/60 460/3/60 575/3/60	3.2 1.3 1.2	3450

Model	Dimensions	Weight	Duct Con.
<b>ARO-600</b>	43" x 21" x 41"ht (1092 x 533 x 1041 mm)	190-230 lb. (104 kg)	6" (152 mm) or 8" (200mm)

## Installation Instructions

- Mount mist collector level.
- Units can be mounted directly on top of machines, on a post or on the wall.
- Ensure that there is free space to change filters.
- Minimize the length of ducting to avoid air flow losses.
- Metal ducting or flexible hose can be used.
- Do not locate suction intake on machining applications in direct line of the cutting spray.
- Install chip strainer. *See details next page*
- Connect the oil drain line using loop in hose or pee trap.
- Loop in hose must be minimum 8" below mist collector, no max. *See instructions page 5.*
- Fill loop with water or oil to create air lock.
- Install motor starter and set overloads.
- Connect electrical power.
- Check motor direction as per arrow on motor.

### Typical installation:

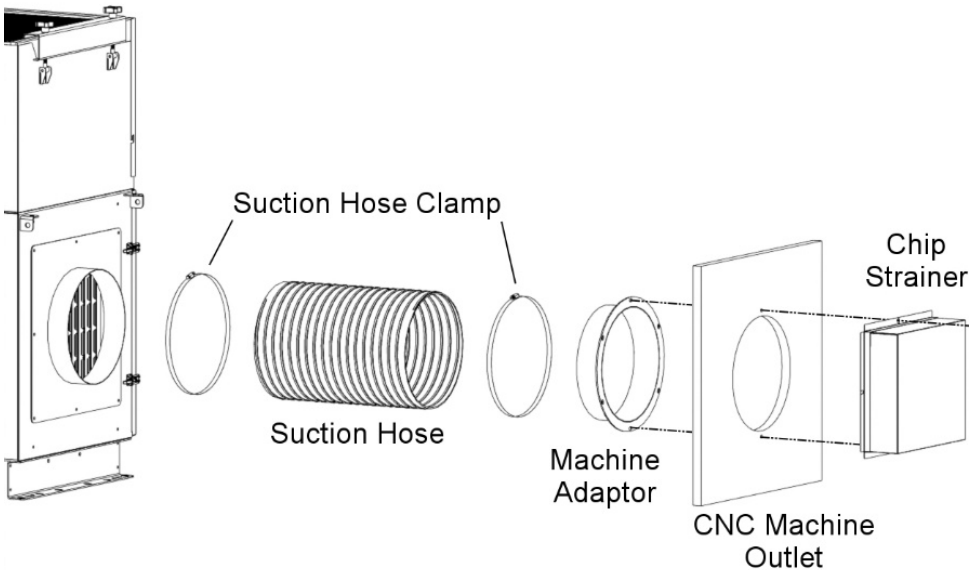

## Installation Kit

Three (3) standard installation kits as follows:

Item	Description	Qty	Part #
1	Installation Kit, 6", with large chip strainer	1	099AIK-0002
1(a)	Suction hose 6"	5ft	099MPH-0006
1(b)	Hose clamp 6"	1	099MHH-0005
1(c)	Machine adaptor 6"	1	099AMS-0006
1(d)	Chip strainer, 6.5" x 8" x 3/4"	1	099ACS-0004
1(d)	Optional chip deflector	1	099ACD-0004
2	Installation Kit, 8"	1	099AIK-0003
2(a)	Suction hose 8"	5ft	099MPH-0008
2(b)	Hose clamp 8"	1	099MHH-0006
2(c)	Machine adaptor 8"	1	099AMS-0008
2(d)	Chip strainer, 8" x 10" x 4"	1	099ACS-0005
2(d)	Optional chip deflector	1	099ACD-0005

## Oil Drain Hose Kit

Item	Description	Qty	Part #
1	Drain Hose Kit, c/w	1	099MPH-0013
1(a)	Oil drain hose	10ft	099MPH-0004
1(b)	Oil drain bracket	1	A99SPM-0002
1(c)	Nipple	1	099MPB-0001
1(d)	Hose clamp	1	099MHH-0002

**Installation:**

Loop in oil drain hose is required to create air lock.

Fill with water, coolant or oil.

Failure to install correctly will result in no oil draining

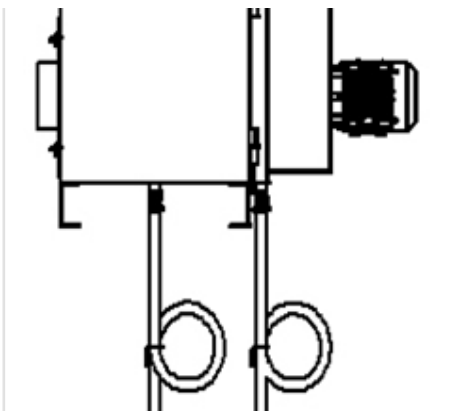





## Electrical Connection

Electrical installation must be performed by a qualified electrical technician and comply with applicable local codes. The motor must have overload protection set to the correct motor amperage.

Most electrical technicians/contractors will be able to supply motor starter panel or install motor contactor in cnc machine electrical panel.

Aeroex offers a selection of motor starter panels as listed below:

1	Manual Motor Starter Start/stop, overloads, no pilot light		4	Motor Starter Panel Remote control with 24 VDC signal Fused disconnect switch, overloads, pilot light.	
2	VFD Motor Starter Panel Fused disconnect switch, start/stop, overloads, pilot light.		5	VFD Motor Starter NEMA 4X enclosure.	
3	Motor Starter Panel Fused disconnect switch, start/stop, overloads, pilot light.				

Mount the motor starter control panel in a convenient location.

Machine mounted mist collectors can be wired into the CNC electrical control.

Connect electrical wires on dual voltage motors (230/460/3/60) according to wire numbers on the motor data plate or the motor manual.

## Direction Of Rotation

### External Motor: (ARO-600)

- Motor direction arrow is located on the motor
- Start/Stop motor
- Check rotation direction
- If incorrect, switch 2 electrical connections, i.e. L1 & L2 (3 phase only)
- Recheck

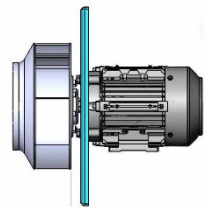

# Wiring Connection

## External Motor Wiring Diagram

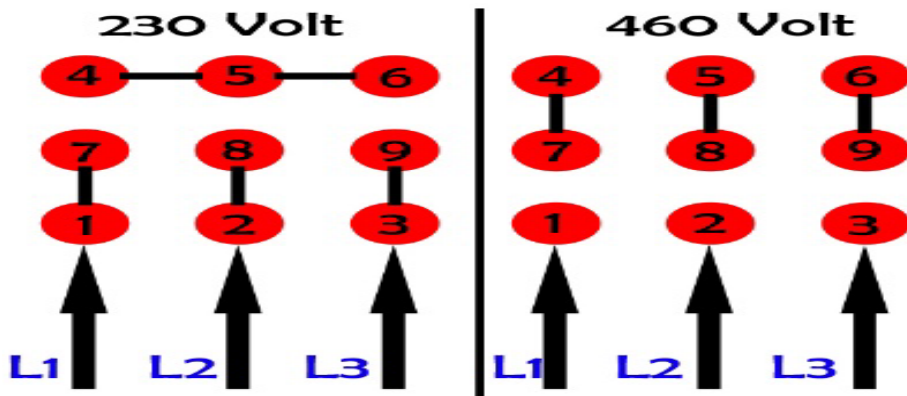

## Maintenance

The mist collector can operate for long periods without maintenance. The maintenance period will depend on the type of oil, coolant & debris in air stream. Inspect the unit after 3 months, 6 months & 1 year to establish the maintenance interval.

The mist collector has one magnehelic gauge measuring the pressure drop on 4<sup>th</sup> stage HEPA filter. Should the gauge reduce to near zero, this indicates no air flow going to HEPA filter, check filter stages 1 to 3 and chip strainer.

### HEPA filter replacement:

Replace when magnehelic pressure gauge reaches the red zone.

### Note:

If filter stages 1 – 3 or chip strainer are plugged, no air flow will go to 4<sup>th</sup> stage HEPA filter and pressure reading can reduce.





# Coolant Filter Options

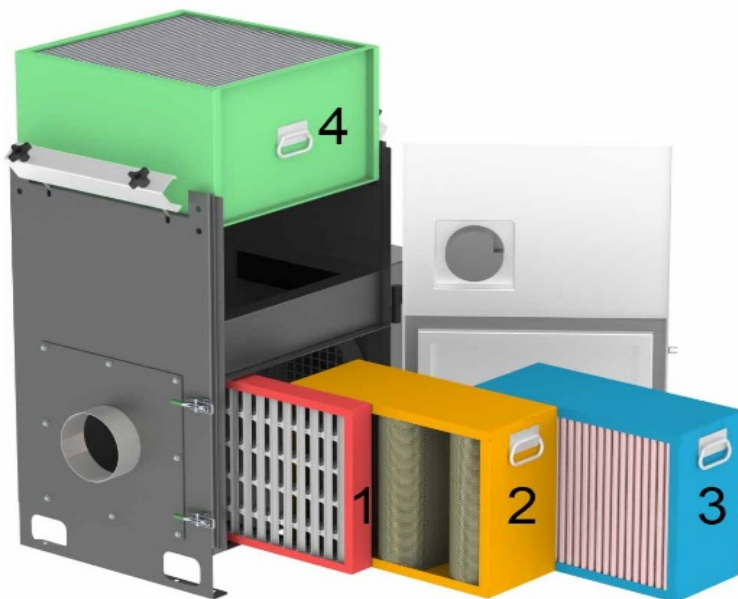

Item #	Description	Part Number
1	1 <sup>st</sup> stage "ME" Mechanical Element	A06FMS-0001
2	2 <sup>nd</sup> stage "AF" Coolant Filter	A06FAF-0001
3	3 <sup>rd</sup> stage "CM" Coolant Mist Filter	A06FCM-0004
4	4 <sup>th</sup> stage "HF" HEPA Filter 95% @ 0.3 microns	600HF-2095
4	4 <sup>th</sup> stage "HF" HEPA Filter HEPA 99.97% @ 0.3 microns (Optional)	600HF-2099
4	4 <sup>th</sup> stage "HF" Odor-Rid HEPA Filter (Optional)	600HF-3095

**Note:**  
Please check filter part # installed in mist collector.

## Oil Filter Options

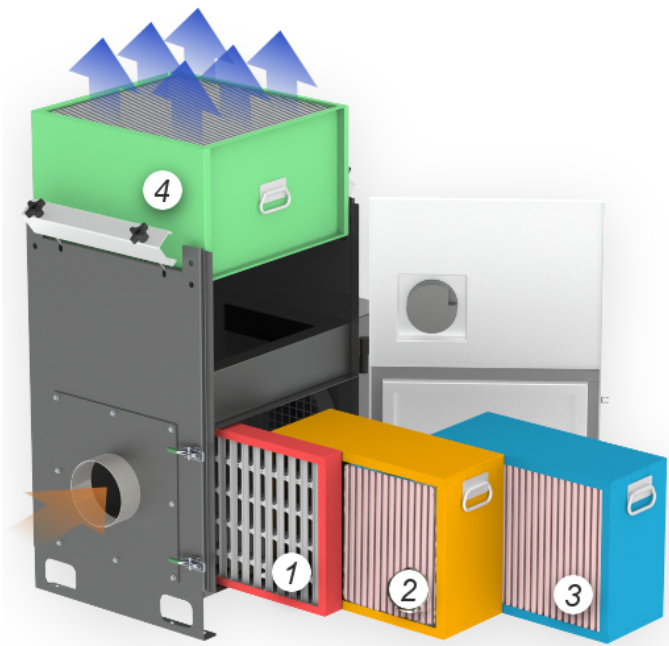

Item #	Description	Part Number
1	1 <sup>st</sup> stage "ME" Mechanical Element	A06FMS-0001
2	2 <sup>nd</sup> stage "OM#5" Oil Mist Fibre Bed Filter	A06FOM-0005
3	3 <sup>rd</sup> stage "OM#7" Oil Mist Fibre Bed Filter	A06FOM-0007
4	4 <sup>th</sup> stage "HF" HEPA Filter 95% @ 0.3 microns	600HF-2095
4	4 <sup>th</sup> stage "HF" HEPA Filter HEPA 99.97% @ 0.3 microns (Optional)	600HF-2099
4	4 <sup>th</sup> stage "HF" Odor-Rid HEPA Filter (Optional)	600HF-3095

**Note:**  
Please check filter part # installed in mist collector.

# Dimensions

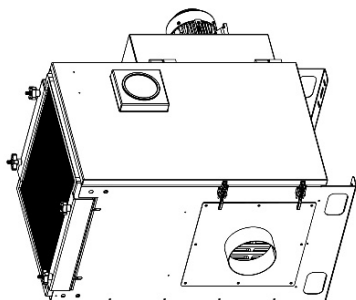

**Note:**  
Left Hand Suction Shown

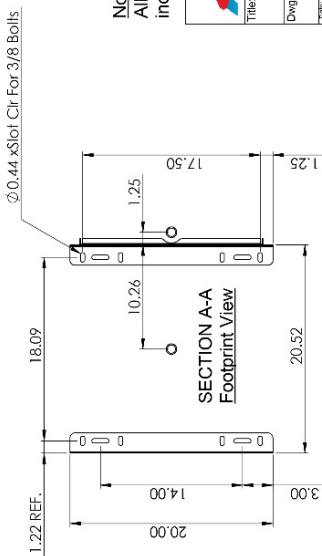
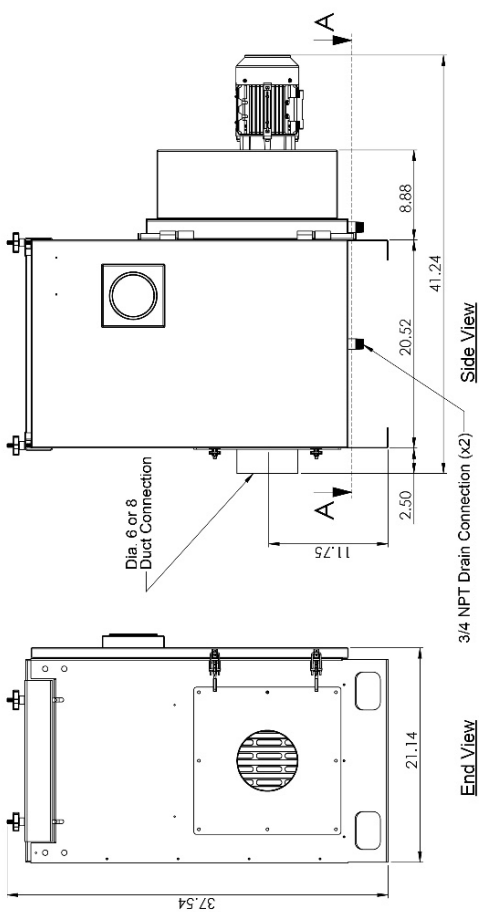

**Note:**  
All dimensions are in inches unless noted otherwise

 Aeroex Technologies Inc. 17 Hamble Road Hamble, NH 03846 Tel: 756-734-0189	
Title:	ARO-600-LH
Dwg. No.	ARO-600-L101-XE
Scale:	1"=1'-0"
Size:	B
Do not scale drawing   Sheet 1 of 1	



## Warranty

### **Limited Warranty**

Aeroex warrants the original purchaser against defects in material and workmanship for five (5) years from date of shipment.

Filters are consumable items and are only warranted to be free of manufacturing defects at time of delivery.

Equipment, parts, or accessories manufactured by others including electric motor, fans and control components carry the guaranty of the manufacturer only.

Any part which is determined to be defective in material or workmanship and returned to an authorized service location, as Aeroex Technologies designates, shipping costs prepaid, will be repaired or replaced at Aeroex Technologies option.

Excluded from the foregoing guarantee are damages caused by ordinary wear and tear, erosion or corrosion, misuse, abuse, or improper handling by the purchaser or any third party.

Aeroex Technologies makes no additional warranties, expressed or implied, whether of merchantability, or otherwise, other than stated above. AEROEX shall not be responsible for any indirect, special or consequential damages, nor for any other claim arising out of the sale, rental, or use of its equipment. AEROEX shall not be liable for special or consequent damages in case of any failure, claims for labour, loss of profits, repairs, alterations, or other expenses incidental to replacement of defective parts or return of the equipment. The Purchaser's sole remedy shall be as stated above.

Aeroex Technologies will make good faith effort for prompt correction or adjustment with respect to any product that proves to be defective within warranty.

Aeroex Technologies Inc.  
17 Hamilton Road  
Barrie ON, L4N 8Y6  
705-734-0199

[orderdesk@aeroex.com](mailto:orderdesk@aeroex.com)  
[sales@aeroex.com](mailto:sales@aeroex.com)  
[www.aeroex.com](http://www.aeroex.com)