



Aeroex Technologies Inc.

Oil Mist Collector

Model ARO-1100 / 1400

Multi-Stage



Installation & Service Manual

www.aeroex.com

705-734-0199

sales@aeroex.com

orderdesk@aeroex.com



Table of Contents

Specifications.....	3
Installation instructions.....	4
Installation Kit.....	5
Oil drain hose Kit.....	5
Electrical Connection.....	6
Direction of rotation.....	6
Wiring Connection.....	7
Maintenance.....	8
Filter options Coolant.....	9
Filter options Oil.....	10
Dimensions.....	11
Warranty.....	12



Model ARO-1100 / 1400 Specifications

AEROEX – Oil Mist Collector

For highly effective separation of coolant and oil mists including smoke from metalworking machinery and oil reservoirs.

Consisting of:

Powdered coated mild steel housing.

Motor and fan impeller or Motorized impeller

-For Coolant, the primary separation pack consists of a 1st stage ME and 2nd stage AG agglo, 3rd stage fiber bed filter. Final filtration, 4th stage HEPA filter.

-For Oil, the primary separation pack consists of a 1st stage ME and 2nd and 3rd stage multi-layer fiber bed filter. Final filtration, 4th stage HEPA filter.

Specifications:

Model	CFM (m ³ /hr)	Sound dB(A)	Machine Tool Enclosure Volume ft ³	Motor hp	Voltage RPM	Amps	RPM
ARO-1100	1100-1300 (1850-2200)	71	450	2.0	230/3/60 460/3/60 575/3/60	5.5 2.7 2.1	3450
ARO-1400	1400-1700 (2380-2890)	72	575	2.0	230/3/60 460/3/60 575/3/60	5.5 2.7 2.1	3450

Model	Dimensions	Weight	Duct Con.
ARO-1100	49" x 25" x 42"ht (1245 x 635 x 1067 mm)	340 lb (154 kg)	8" (200mm) 10" (254 mm)
ARO-1400	49" x 25" x 42"ht (1245 x 635 x 1067 mm)	340 lb (154 kg)	10" (254 mm) 12" (304.8 mm)

Installation Instructions

- Mount mist collector level.
- Units can be mounted directly on top of machines, on a post or on the wall.
- Ensure that there is free space to change filters.
- Minimize the length of ducting to avoid air flow losses.
- Metal ducting or flexible hose can be used.
- Do not locate suction intake on machining applications in direct line of the cutting spray.
- Install chip strainer. *See details next page*
- Connect the oil drain line using loop in hose or pee trap.
- Loop in hose must be minimum 8" below mist collector, no max. *See instructions page 5.*
- Fill loop with water or oil to create air lock.
- Install motor starter and set overloads.
- Connect electrical power.
- Check motor direction as per arrow on motor.

Typical installation:

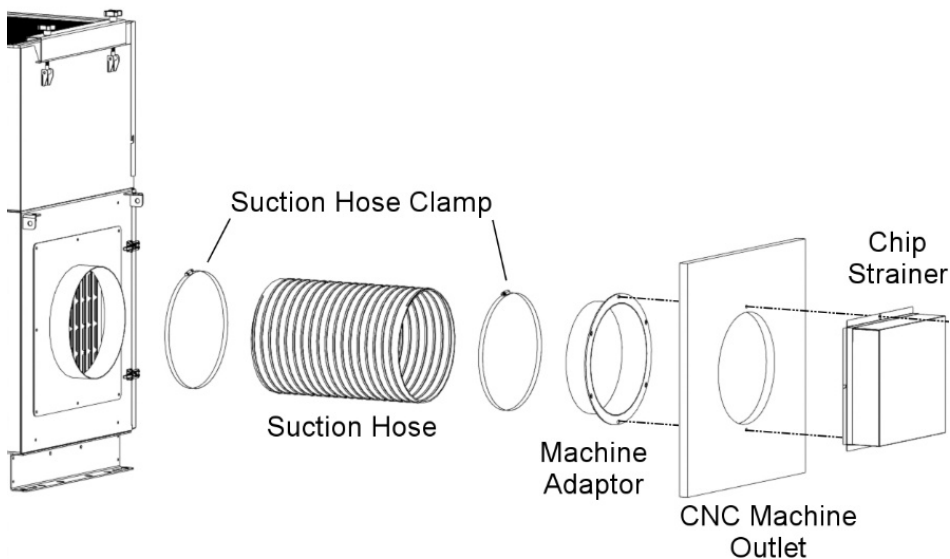

Installation Kit

Three (3) standard installation kits as follows:

Item	Description	Qty	Part #
1	Installation Kit, 8"	1	099AIK-0003
1(a)	Suction hose 8"	5ft	099MPH-0010
1(b)	Hose clamp 8"	1	099MHH-0007
1(c)	Machine adaptor 8"	1	099AMS-0008
1(d)	Chip strainer, 8.5"x10"x4"	1	099ACS-0005
1(d)	Optional chip deflector	1	099ACD-0006
2	Installation Kit, 10"	1	099AIK-0004
2(a)	Suction hose 10"	5ft	099MPH-0008
2(b)	Hose clamp 10"	1	099MHH-0006
2(c)	Machine adaptor 10"	1	099AMS-0010
2(d)	Chip strainer, 10.5" x 12" x 4"	1	099ACS-0005
2(d)	Optional chip deflector	1	099ACD-0005
3	Installation Kit, 12"	1	099AIK-0005
3(a)	Suction hose 12"	5ft	099MPH-0012
3(b)	Hose clamp 12"	1	099MHH-0008
3(c)	Machine adaptor 12"	1	099AMS-0012
3(d)	Chip strainer, 12.5"x14"x4"	1	099ACS-0006
3(d)	Optional chip deflector	1	099ACD-0006

Oil Drain Hose Kit

Item	Description	Qty	Part #
1	Drain Hose Kit, c/w	1	099MPH-0013
1(a)	Oil drain hose	10ft	099MPH-0004
1(b)	Oil drain bracket	1	A99SPM-0002
1(c)	Nipple	1	099MPB-0001
1(d)	Hose clamp	1	099MHH-0002

Installation:

Loop in oil drain hose is required to create air lock.

Fill with water, coolant or oil.

Failure to install correctly will result in no oil draining

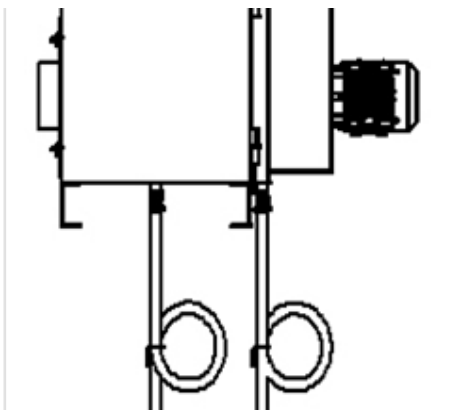





Electrical Connection

Electrical installation must be performed by a qualified electrical technician and comply with applicable local codes. The motor must have overload protection set to the correct motor amperage.

Most electrical technicians/contractors will be able to supply motor starter panel or install motor contactor in cnc machine electrical panel.

Aeroex offers a selection of motor starter panels as listed below:

1	Manual Motor Starter Start/stop, overloads, no pilot light		4	Motor Starter Panel Remote control with 24 VDC signal Fused disconnect switch, overloads, pilot light.	
2	VFD Motor Starter Panel Fused disconnect switch, start/stop, overloads, pilot light.		5	VFD Motor Starter NEMA 4X enclosure.	
3	Motor Starter Panel Fused disconnect switch, start/stop, overloads, pilot light.				

Mount the motor starter control panel in a convenient location.

Machine mounted mist collectors can be wired into the CNC electrical control.

Connect electrical wires on dual voltage motors (230/460/3/60) according to wire numbers on the motor data plate or the motor manual.

Direction of Rotation

External Motor: (ARO-1400)

- Motor direction arrow is located on the motor
- Start/Stop motor
- Check rotation direction
- If incorrect, switch 2 electrical connections, i.e. L1 & L2 (3 phase only)
- Recheck

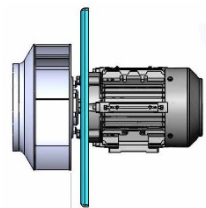

Wiring Connection

External Motor Wiring Diagram

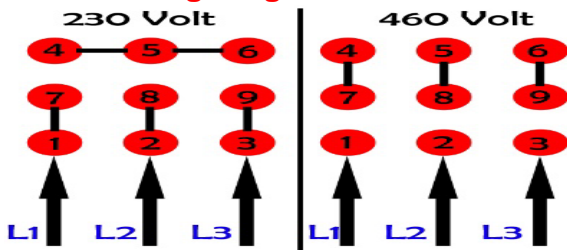

Maintenance

The mist collector can operate for long periods without maintenance. The maintenance period will depend on the type of oil, coolant & debris in air stream. Inspect the unit after 3 months, 6 months & 1 year to establish the maintenance interval.

The mist collector has one magnehelic gauge measuring the pressure drop on 4th stage HEPA filter. Should the gauge reduce to near zero, this indicates no air flow going to HEPA filter, check filter stages 1 to 4 and chip strainer.

HEPA filter replacement:

Replace when magnehelic pressure gauge reaches the red zone.

Note:

If filter stages 1 – 3 or chip strainer are plugged, no air flow will go to 4th stage HEPA filter and pressure reading can reduce.



Filter Options Coolant

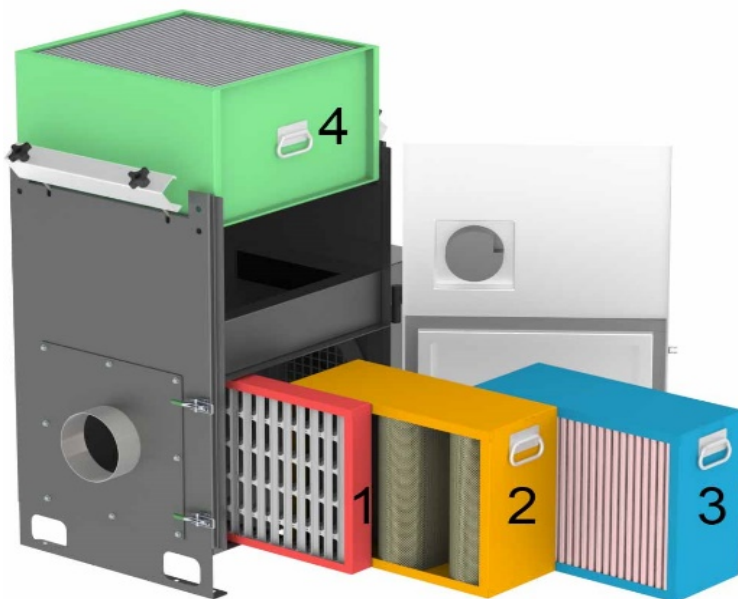

Item #	Description	Part Number
1	1 st stage "ME" Mechanical Element	A11FMS-0001
2	2 nd stage "AF" Coolant Filter	A11FAF-0001
3	3 rd stage "CM" Coolant Mist Filter	A11FCM-0004
4	4 th stage "HF" HEPA Filter 95% @ 0.3 microns	2000HF-2095
4	4 th stage "HF" HEPA Filter HEPA 99.97% @ 0.3 microns (Optional)	2000HF-2099
4	4 th stage "HF" Odor-Rid HEPA Filter (Optional)	2000HF-3095

Note:
Please check filter part # installed in mist collector.

Filter Options Oil

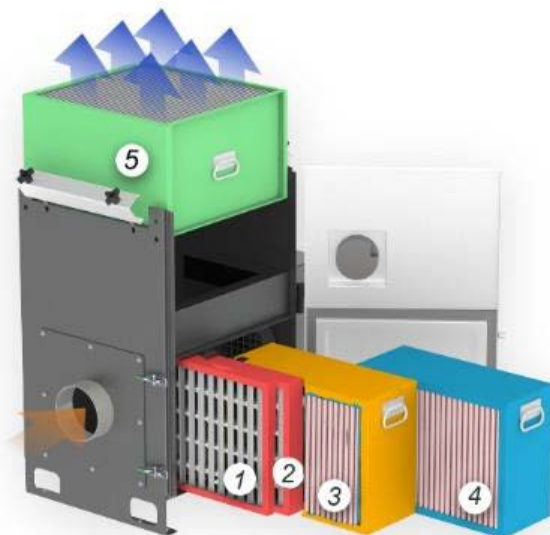

Item #	Description	Part Number
1	1 st stage "ME" Mechanical Element	A11FMS-0001
2	2 nd stage "DE" Demister Element	A11FDE-0002
3	3rd Stage "OM#5" Oil Mist Fibre Bed Filter	A11FOM-0005
4	4th Stage "OM#7" Oil Mist Fibre Bed Filter	A11FOM-0007
5	4 th stage "HF" HEPA Filter 95% @ 0.3 microns	2000HF-2095
5	4 th stage "HF" HEPA Filter HEPA 99.97% @ 0.3 microns (Optional)	2000HF-2099
5	4 th stage "HF" Odor-Rid HEPA Filter (Optional)	2000HF-3095

Note:
Please check filter part # installed in mist collector.

Dimensions

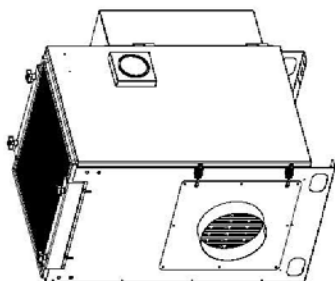

Note:
Left Hand Model Shown

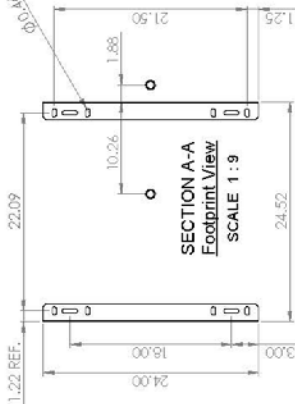
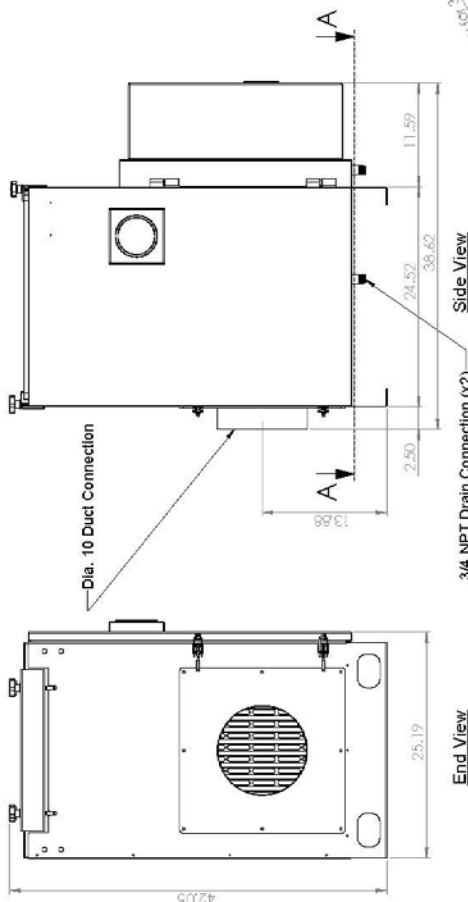

Note:
All dimensions are in inches unless noted otherwise

Aeroex Technologies Inc.
47 Hampton Road
Hampton, NJ 08034
Tel: 856-734-8878

Title: ARO-1100-LH w Motorized 280 Impeller
Dwg No. ARO-1100-L102-XA
Size **B**



Warranty

Limited Warranty

Aeroex warrants the original purchaser against defects in material and workmanship for five (5) years from date of shipment.

Filters are consumable items and are only warranted to be free of manufacturing defects at time of delivery.

Equipment, parts, or accessories manufactured by others including electric motor, fans and control components carry the guaranty of the manufacturer only.

Any part which is determined to be defective in material or workmanship and returned to an authorized service location, as Aeroex Technologies designates, shipping costs prepaid, will be repaired or replaced at Aeroex Technologies option.

Excluded from the foregoing guarantee are damages caused by ordinary wear and tear, erosion or corrosion, misuse, abuse, or improper handling by the purchaser or any third party.

Aeroex Technologies makes no additional warranties, expressed or implied, whether of merchantability, or otherwise, other than stated above. AEROEX shall not be responsible for any indirect, special or consequential damages, nor for any other claim arising out of the sale, rental, or use of its equipment. AEROEX shall not be liable for special or consequent damages in case of any failure, claims for labour, loss of profits, repairs, alterations, or other expenses incidental to replacement of defective parts or return of the equipment. The Purchaser's sole remedy shall be as stated above.

Aeroex Technologies will make good faith effort for prompt correction or adjustment with respect to any product that proves to be defective within warranty.

Aeroex Technologies Inc.
17 Hamilton Road
Barrie ON, L4N 8Y6
705-734-0199

orderdesk@aeroex.com
sales@aeroex.com
www.aeroex.com