

8 7 6 5 4 3 2 1

D
C
B
A

D
C
B
A

Leave adequate clearance
to ceiling for filter changes

Access Door
Leave adequate clearance
for filter change

Mist-Fit MF-560

CNC Machine Side

Side Mount

Hex Bolt 1/4"-20 (x6)
with 1/4" Sealing Washer

Hex Bolt 1/4"-20 (x9)

Apply a sealant
to mating surface
if required

Hex Nut 1/4"-20 (x9)

Sealing Washer 1/4" (x9)

Side Mount 13" w x 16" h

Drill clearance holes for 1/4" bolts
in a suitable location
use Side Mount as a template

Cut a 8 inch diameter hole
to suit the Side Mount
if no machine knock out is provided

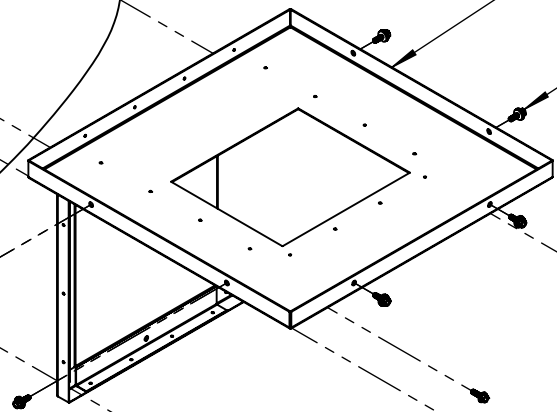
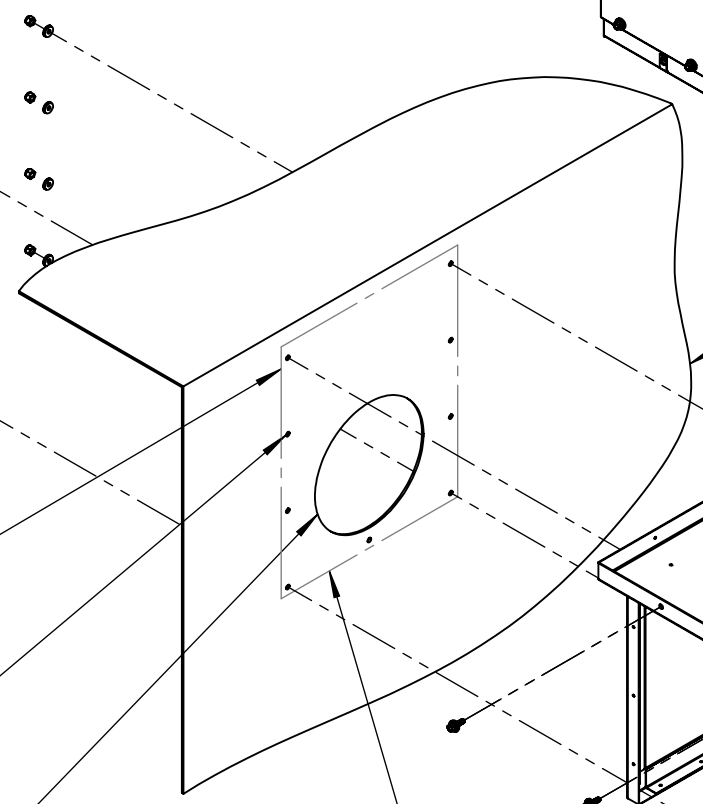
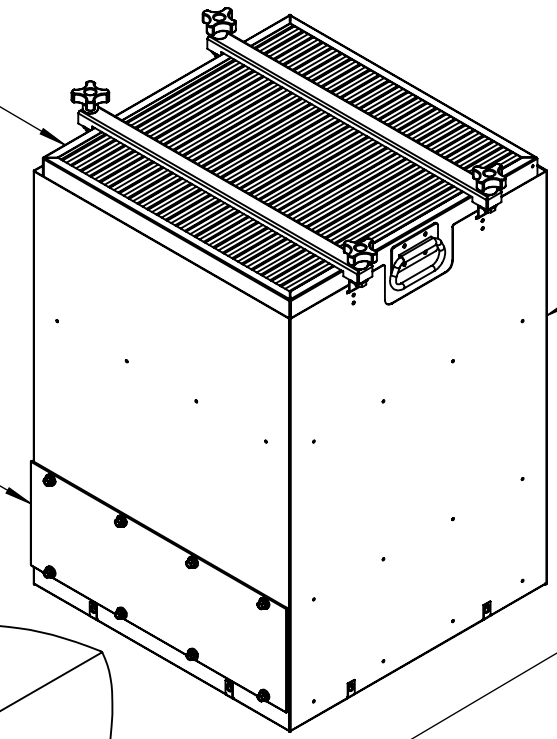

AEROEX Aeroex Technologies Inc.
17 Hamilton Road
Barrie, On L4N 8Y6
Tel. 705-734-0199

Title: Installation, MF-560, Side Mount

Dwg. No. M06MBD-0014-C Size **B**

Date: March 12, 2019 Drawn: T.B. Do not scale drawing Sheet 1 of 1

8 7 6 5 4 3 2 1

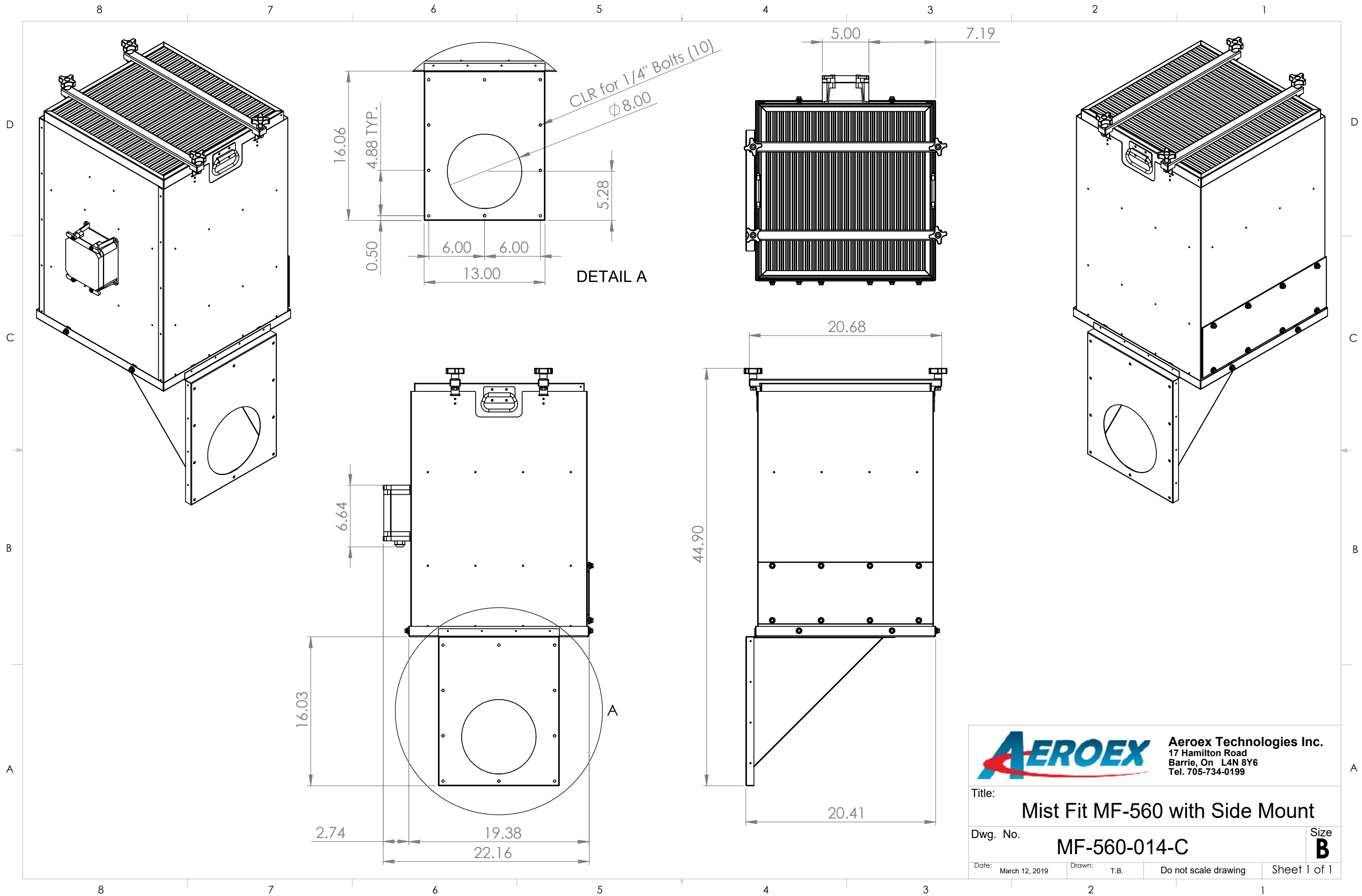

AEROEX Aeroex Technologies Inc.
 17 Hamilton Road
 Barrie, On L4N 8Y6
 Tel. 705-734-0199

Title: Mist Fit MF-560 with Side Mount

Dwg. No. MF-560-014-C

Date: March 12, 2019 Drawn: T.B. Do not scale drawing Sheet 1 of 1

Size **B**