

8 7 6 5 4 3 2 1

D

D

C

C

B

B

A

A

Leave adequate clearance to ceiling for filter changes

Access Door
Leave adequate clearance for filter change

Hex Bolt 1/4"-20 (x4) with 1/4" Sealing Washer

Hex Nut 1/4"-20 (x4)

Floor Stand
Available 6', 7' or 8' high

Cleared for 1/2" Bolts (4)
Attach to suitable floor using appropriate fasteners

Mist-Fit MF-1050

Base Plate

Hex Bolt 1/4"-20 (x8) with 1/4" Sealing Washer

Hose Clamp 8" (x2)

Suction Hose 8"

Hex Bolt 1/4"-20 (x6) Machine Adaptor 8"

Apply a sealant to mating surface of Machine Adaptor

CNC Machine Top

Cut a 8 inch diameter hole in a suitable location if no machine knock out is provided

Drill clearance holes for 1/4" bolts use Machine Adaptor as a template and drill to suit

Chip Strainer 8"

Sealing Washer 1/4" (x6)

Hex Nut 1/4"-20 (x6)



Aeroex Technologies Inc.
17 Hamilton Road
Barrie, On L4N 8Y6
Tel. 705-734-0199

Title: Installation, MF-1050, Floor Stand

Dwg. No. M10MBD-0026-C Size B

Date: March 7, 2019 Drawn: T.B. Do not scale drawing Sheet 1 of 1

8 7 6 5 4 3 2 1

FOOTPRINT VIEW
SECTION A-A

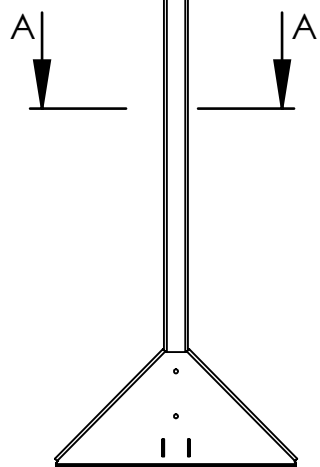
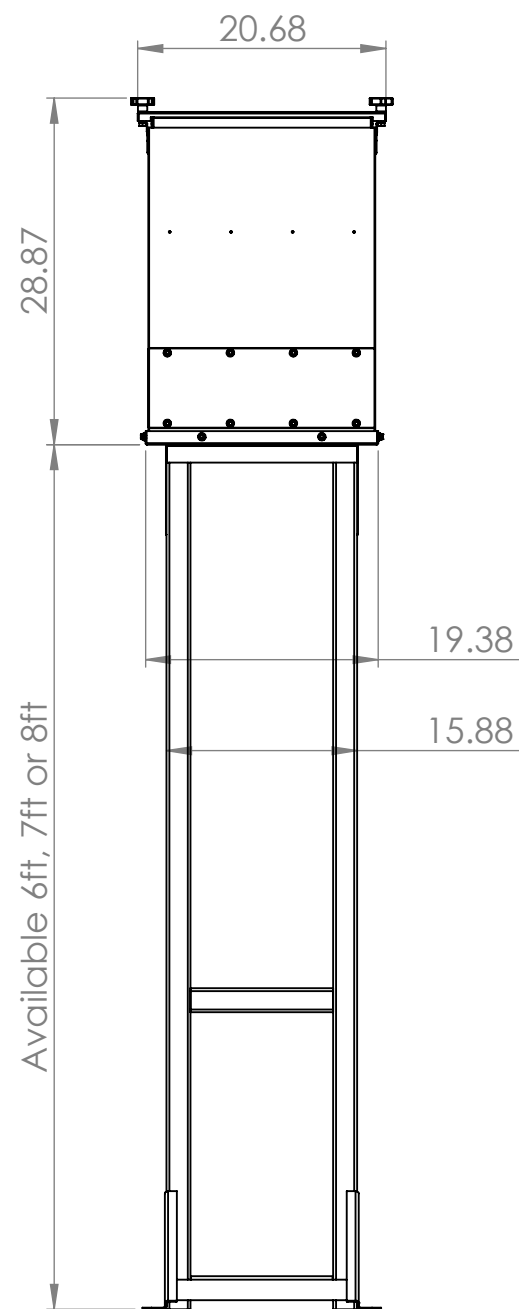
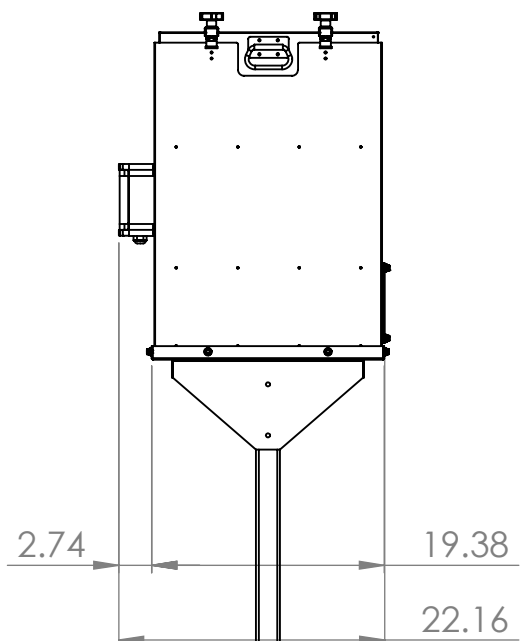
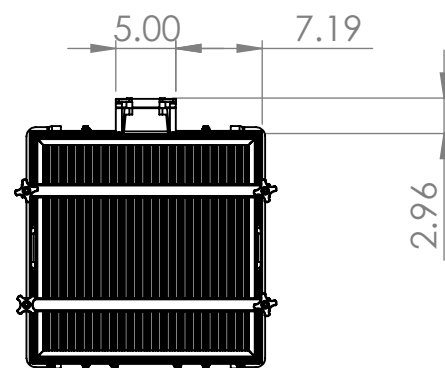
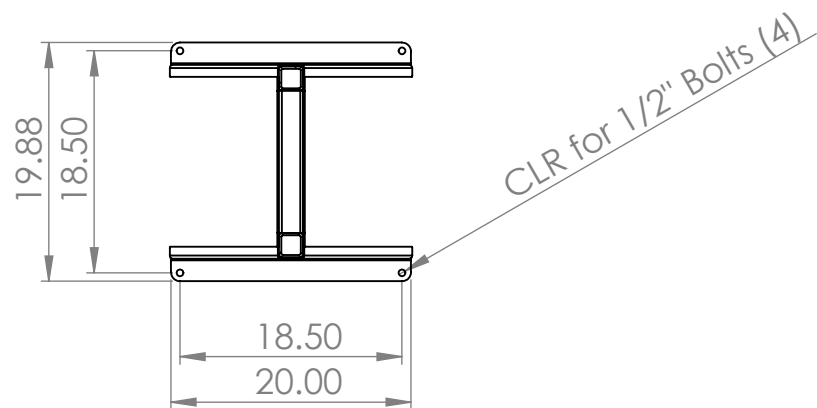

AEROEX Aeroex Technologies Inc.
17 Hamilton Road
Barrie, On L4N 8Y6
Tel. 705-734-0199

Title: Mist-Fit MF-1050 with 6ft Floor Stand

Dwg. No. MF-1050-026-C Size **B**

Date: March 12, 2019 Drawn: T.B. Do not scale drawing Sheet 1 of 1