



Aeroex Technologies Inc.

Oil Mist Collector

Model ARO-2000

Multi-Stage



Installation & Service Manual

www.aeroex.com

705-734-0199

sales@aeroex.com

orderdesk@aeroex.com



Table Of Contents

Specifications.....	3
Installation instructions.....	4
Installation Kit.....	5
Oil drain hose Kit.....	5
Electrical.....	6
Direction of rotation.....	7
Maintenance.....	8
Filter options Coolant.....	9
Filter options Oil.....	10
Dimensions.....	11
Warranty.....	12



Model ARO-2000 Specifications

AEROEX – Oil Mist Collector

For highly effective separation of coolant and oil mists including smoke from metalworking machinery and oil reservoirs.

Consisting of:

Powdered coated mild steel housing.

Motor and fan impeller or Motorized impeller

-For Coolant, the primary separation pack consists of a 1st stage ME and 2nd stage AG agglo, 3rd stage fiber bed filter. Final filtration, 4th stage HEPA filter.

-For Oil, the primary separation pack consists of a 1st stage ME and 2nd and 3rd stage multi-layer fiber bed filter. Final filtration, 4th stage HEPA filter.

Specifications:

Model	CFM (m ³ /hr)	Sound dB(A)	Machine Tool Enclosure Volume ft ³	Motor hp	Voltage RPM	Amps	RPM
ARO-2000	1750- 2000 (3000- 3400)	74	750	3	208/3/60 230/460/3/60 575/3/60	7.7 7.6/3.8 3.1	3450

Model	Dimensions	Weight	Duct Con.
ARO-2000	46" x 25" x 48"ht (1168 x 635 x 1220 mm)	380 lb (172 kg)	12" (305 mm)

Installation:

- Mount mist collector level.
- Units can be mounted directly on top of machines, on a post or on the wall.
- Ensure that there is free space to change filters.
- Minimize the length of ducting to avoid air flow losses.
- Metal ducting or flexible hose can be used.
- Do not locate suction intake on machining applications in direct line of the cutting spray.
- Install chip strainer. *See details next page*
- Connect the oil drain line using loop in hose or pee trap.
- Loop in hose must be minimum 8" below mist collector, no max. *See instructions page 5.*
- Fill loop with water or oil to create air lock.
- Install motor starter and set overloads.
- Connect electrical power.
- Check motor direction as per arrow on motor.

Typical installation:

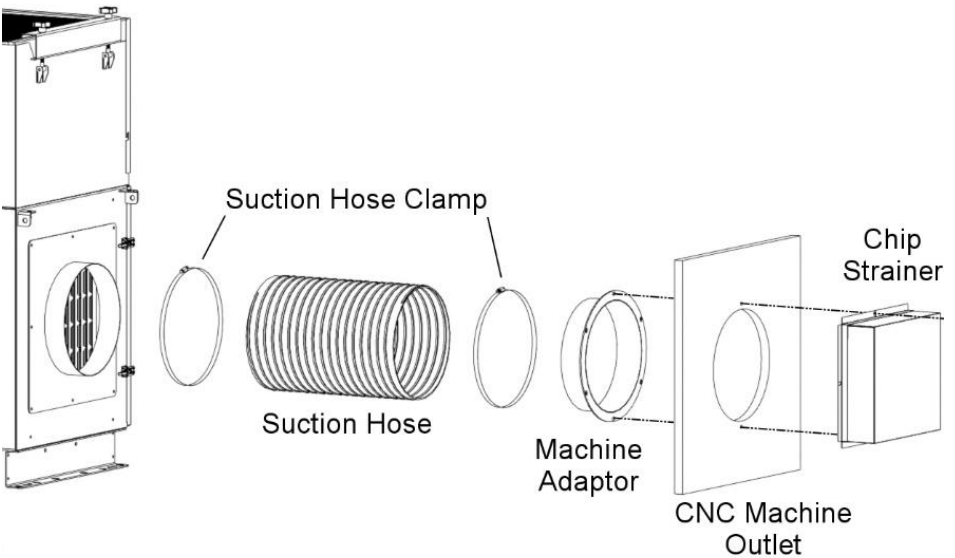

Installation kit:

Item	Description	Qty	Part #
1	Installation Kit, 12"	1	099AIK-0005
1(a)	Suction hose 12"	5ft	099MPH-0012
1(b)	Hose clamp 12"	1	099MHH-0008
1(c)	Machine adaptor 12"	1	099AMS-0012
1(d)	Chip strainer, 12.5"x14"x4"	1	099ACS-0006
1(d)	Optional chip deflector	1	099ACD-0006

Oil Drain Hose Kit :

Item	Description	Qty	Part #
1	Drain Hose Kit, c/w	1	099MPH-0013
1(a)	Oil drain hose	10ft	099MPH-0004
1(b)	Oil drain bracket	1	A99SPM-0002
1(c)	Nipple	1	099MPB-0001
1(d)	Hose clamp	1	099MHH-0002

Installation:

Loop in oil drain hose is required to create air lock.

Fill with water, coolant or oil.

Failure to install correctly will result in no oil draining

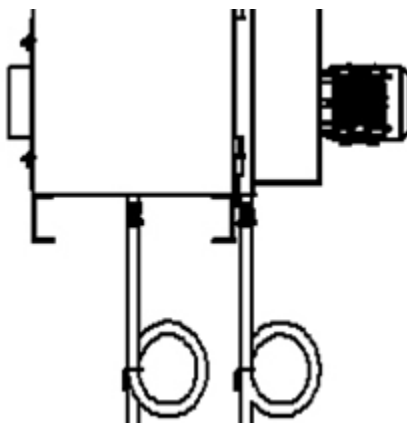





Electrical Connection:

Electrical installation must be performed by a qualified electrical technician and comply with applicable local codes. The motor must have overload protection set to the correct motor amperage.

Most electrical technicians/contractors will be able to supply motor starter panel or install motor contactor in cnc machine electrical panel.

Aeroex offers a selection of motor starter panels as listed below:

1	Manual Motor Starter Start/stop, overloads, no pilot light		4	Motor Starter Panel Remote control with 24 VDC signal Fused disconnect switch, overloads, pilot light.	
2	VFD Motor Starter Panel Fused disconnect switch, start/stop, overloads, pilot light.		5	VFD Motor Starter NEMA 4X enclosure.	
3	Motor Starter Panel Fused disconnect switch, start/stop, overloads, pilot light.				

Mount the motor starter control panel in a convenient location.

Machine mounted mist collectors can be wired into the CNC electrical control.

Connect electrical wires on dual voltage motors (230/460/3/60) according to wire numbers on the motor data plate or the motor manual.

Direction Of Rotation:

Motor: (ARO-2000)

- Motor direction arrow is located on the motor
- Start/Stop motor
- Check rotation direction
- If incorrect, switch 2 electrical connections, ie L1 & L2 (3 phase only)
- Recheck

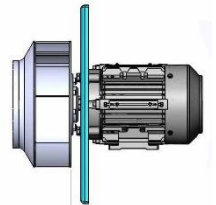

Electrical Connection:

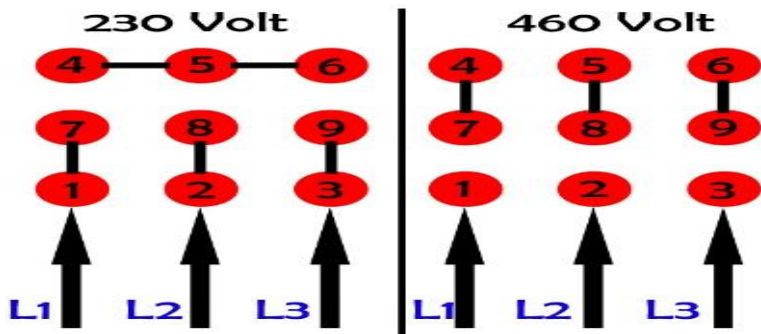

Maintenance:

The mist collector can operate for long periods without maintenance. The maintenance period will depend on the type of oil, coolant & debris in air stream. Inspect the unit after 3 months, 6 months & 1 year to establish the maintenance interval.

The mist collector has one magnehelic gauge measuring the pressure drop on 4th stage HEPA filter. Should the gauge reduce to near zero, this indicates no air flow going to HEPA filter, check filter stages 1 to 3 and chip strainer.

HEPA filter replacement:

Replace when magnehelic pressure gauge reaches the red zone.

Note:

If filter stages 1 – 3 or chip strainer are plugged, no air flow will go to 4th stage HEPA filter and pressure reading can reduce.



Filter Options



Item #	Description	Part Number
1	1 st stage Mechanical Element pack	A20FMS-0001
2	2 nd stage Agglomerator filter pack for coolant	A20FAF-0001
3	3 rd stage fiber bed filter for coolant	A20FCM-0004
4	4 th stage filter HEPA 95% @ 0.3 microns	2000HF-2095
4	4 th stage filter HEPA 99.97% @ 0.3 microns (Optional)	2000HF-2099

Note:
Please check filter part # installed in mist collector.

Filter Options

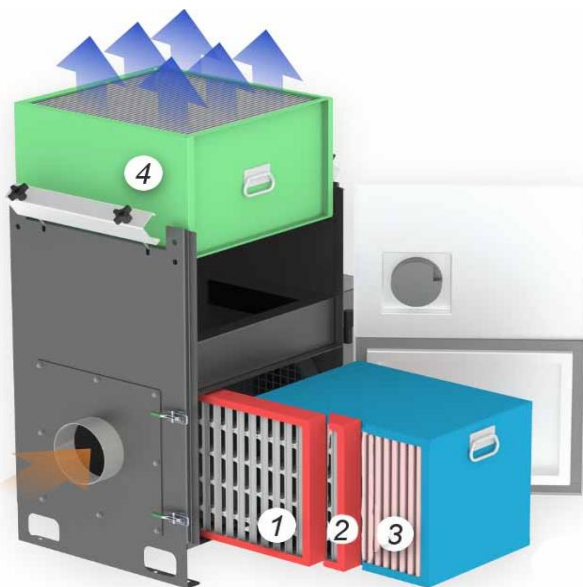

Item #	Description	Part Number
1	1 st stage Mechanical Element pack	A20FMS-0001
2	2 nd stage "DE" Demister Element	A20FDE-0002
3	3 rd Stage "OM" #3 Oil Mist Pack For low viscosity oils and high smoke.	A20FOM-0003
4	4 th stage filter HEPA 95% @ 0.3 microns	2000HF-2095
4	4 th stage filter HEPA 99.97% @ 0.3 microns (Optional)	2000HF-2099

Note:
Please check filter part # installed in mist collector.

Dimensions

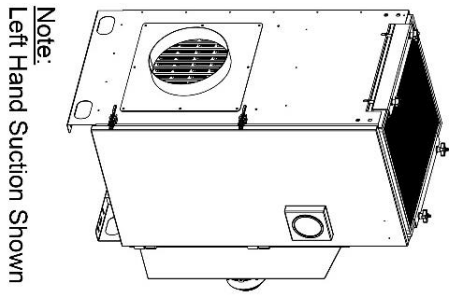
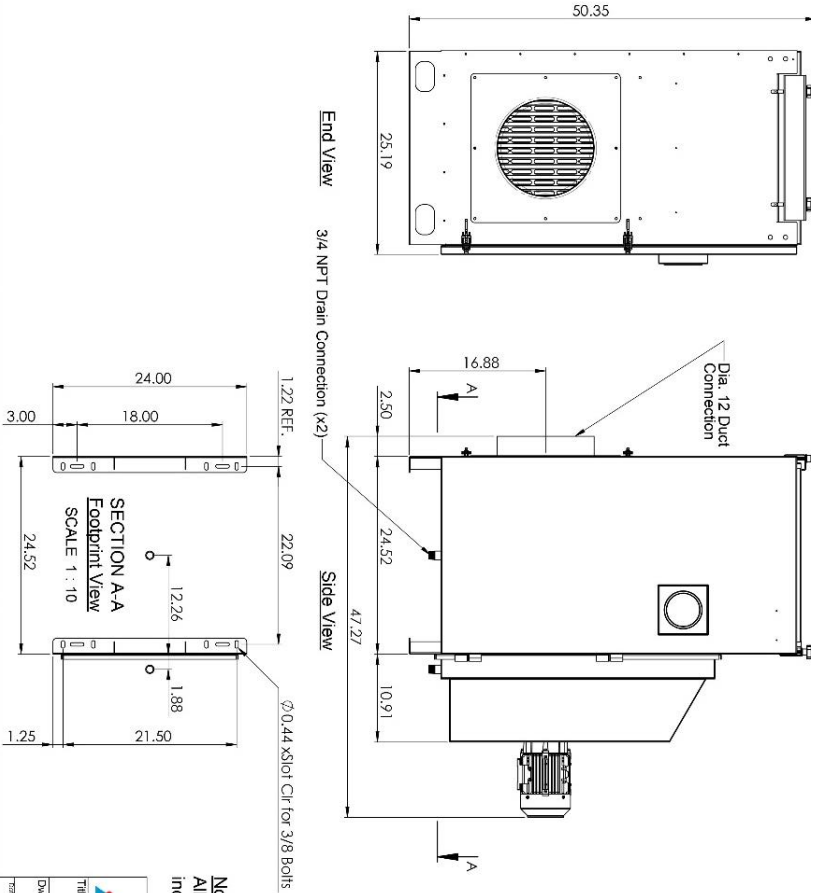

Note:
All dimensions are in inches unless noted otherwise

Aeroex Technologies Inc. 10000 Aeroex Blvd, Suite 100 Bakersfield, CA 93311 Tel: 805-324-4199	
Title: ARO-2000-LH	Dwg. No. ARO-2000-L103-XC
Date: October 4, 2017	Revision: 1.0
Drawn by: Crawford	Checked by: Crawford
Sheet 1 of 1	
Size B	



Warranty:

Limited Warranty

Aeroex warrants the original purchaser against defects in material and workmanship for five (5) years from date of shipment.

Filters are consumable items and are only warranted to be free of manufacturing defects at time of delivery.

Equipment, parts, or accessories manufactured by others including electric motor, fans and control components carry the guaranty of the manufacturer only.

Any part which is determined to be defective in material or workmanship and returned to an authorized service location, as Aeroex Technologies designates, shipping costs prepaid, will be repaired or replaced at Aeroex Technologies option.

Excluded from the foregoing guarantee are damages caused by ordinary wear and tear, erosion or corrosion, misuse, abuse, or improper handling by the purchaser or any third party.

Aeroex Technologies makes no additional warranties, expressed or implied, whether of merchantability, or otherwise, other than stated above. AEROEX shall not be responsible for any indirect, special or consequential damages, nor for any other claim arising out of the sale, rental, or use of its equipment. AEROEX shall not be liable for special or consequent damages in case of any failure, claims for labour, loss of profits, repairs, alterations, or other expenses incidental to replacement of defective parts or return of the equipment. The Purchaser's sole remedy shall be as stated above.

Aeroex Technologies will make good faith effort for prompt correction or adjustment with respect to any product that proves to be defective within warranty.

Aeroex Technologies Inc.
17 Hamilton Road
Barrie ON, L4N 8Y6
705-734-0199

orderdesk@aeroex.com
sales@aeroex.com
www.aeroex.com